

# SHIP PLAN

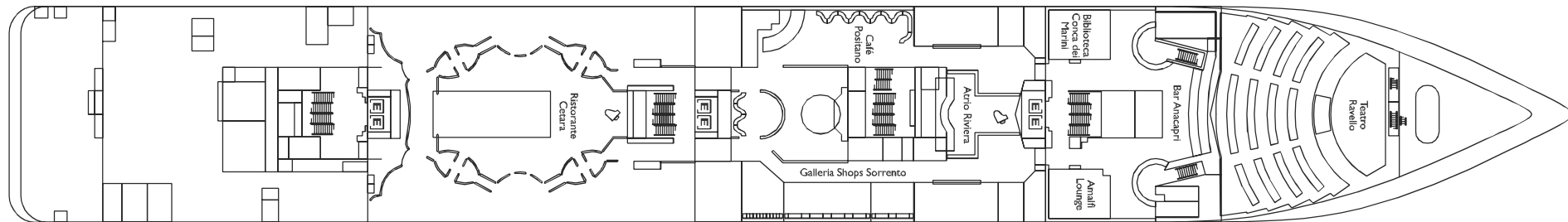
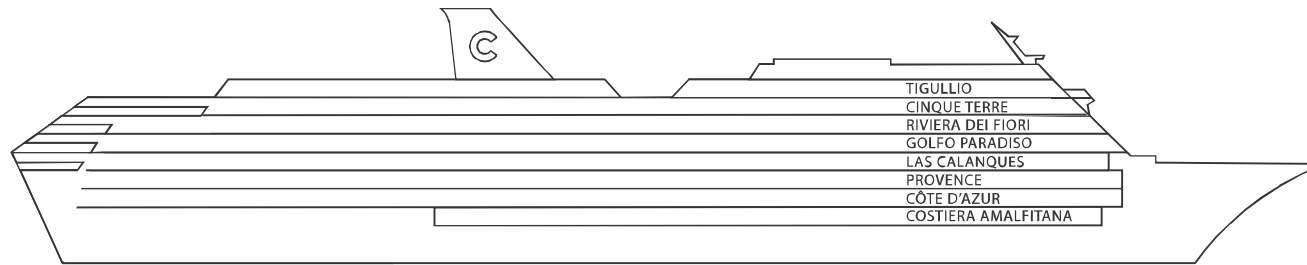

DECK 5 - COSTIERA AMALFITANA

## Inside cabins

- **Classic** Les Calanques, Provence
- **Premium** Les Calanques, Golfo Paradiso, Riviera dei Fiori

## Outside cabins with ocean view

- **Classic** Les Calanques, Provence
- **Premium** Les Calanques, Golfo Paradiso, Riviera dei Fiori

## Cabins with ocean view balcony

- **Classic** Golfo Paradiso, Riviera dei Fiori

## Luxury Suites

- **Veranda Mini-Suites**  
Golfo Paradiso
- **Veranda Suites**  
Golfo Paradiso, Riviera dei Fiori
- **Veranda Panorama Suites**  
Provence, Les Calanques
- **Veranda Grand Suites**  
Provence, Les Calanques

**NB:** A double bed is available in cabins of all categories.  
A 3<sup>rd</sup> bed is available in cabins of all categories.  
A 4<sup>th</sup> bed is available in cabins of all categories except for Classic and Premium outside cabins.

- single cabins
- H cabins for disabled guests
- ⌋ connecting cabins
- E elevator
- \* sofa double bed
- 1 upper berth
- sofa single bed
- ▲▲ 2 lower berths that can't be converted into a double bed
- ▲ can't be converted into a double bed

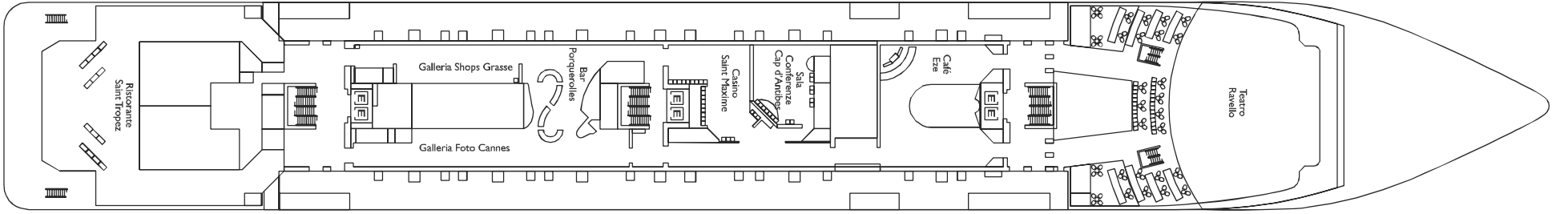

DECK 6 - CÔTE D'AZUR

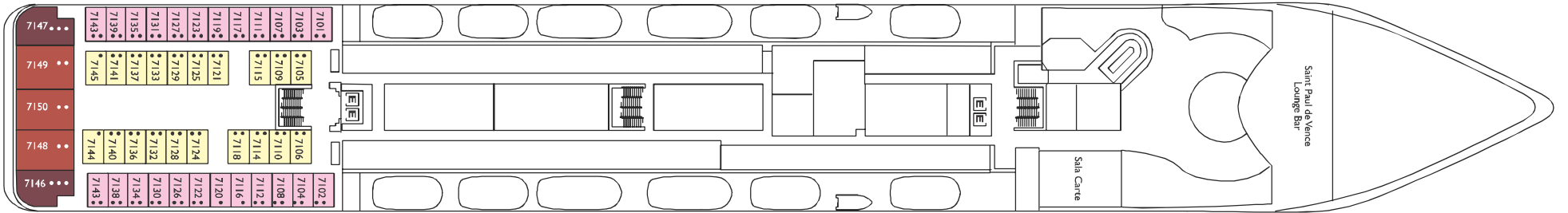

DECK 7 - PROVENCE

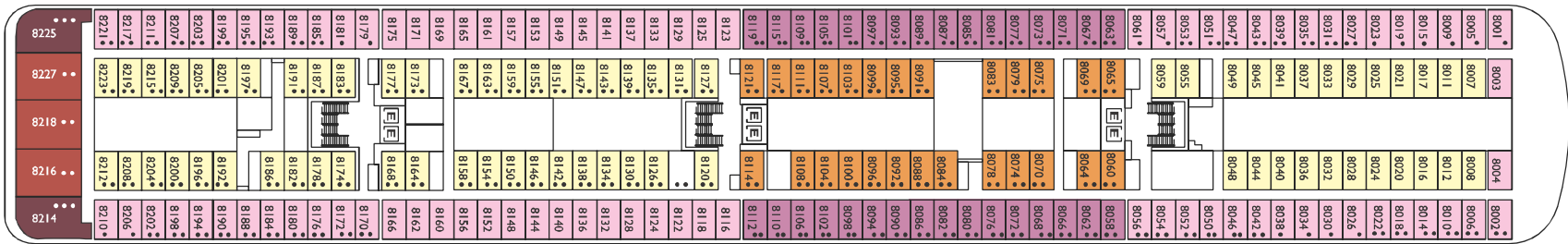

DECK 8 - LES CALANQUES

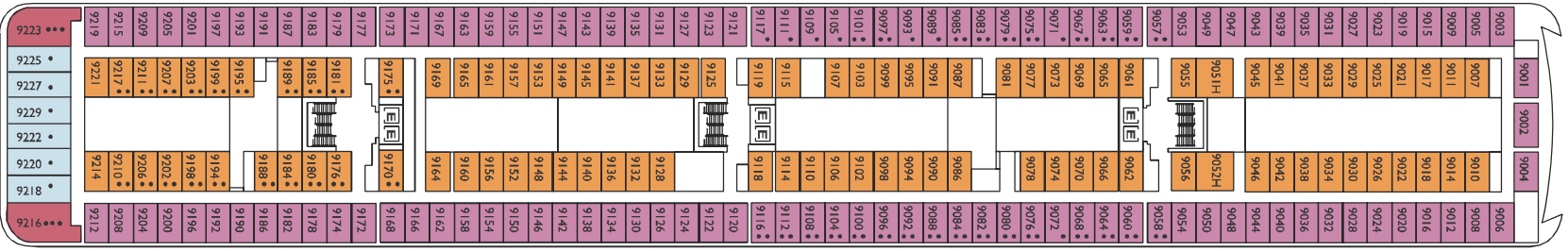

DECK 9 - GOLFO PARADISO

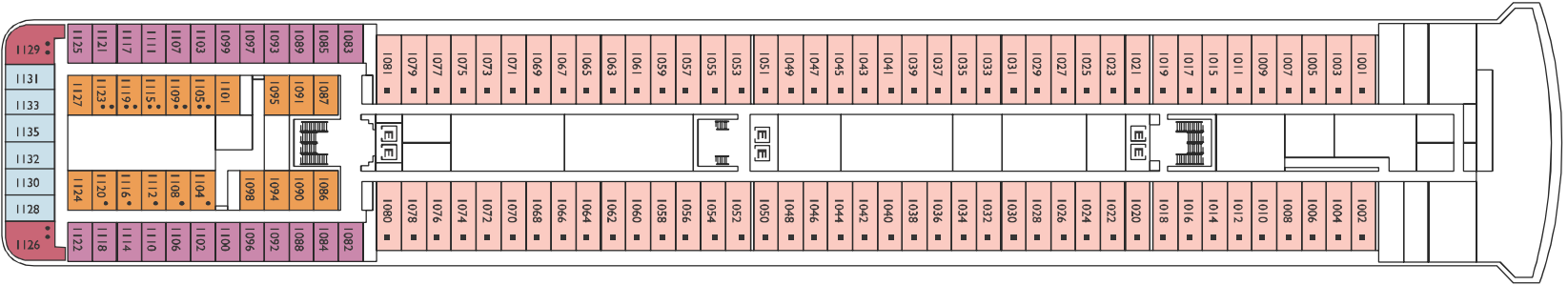

DECK 10 - RIVIERA DEI FIORI

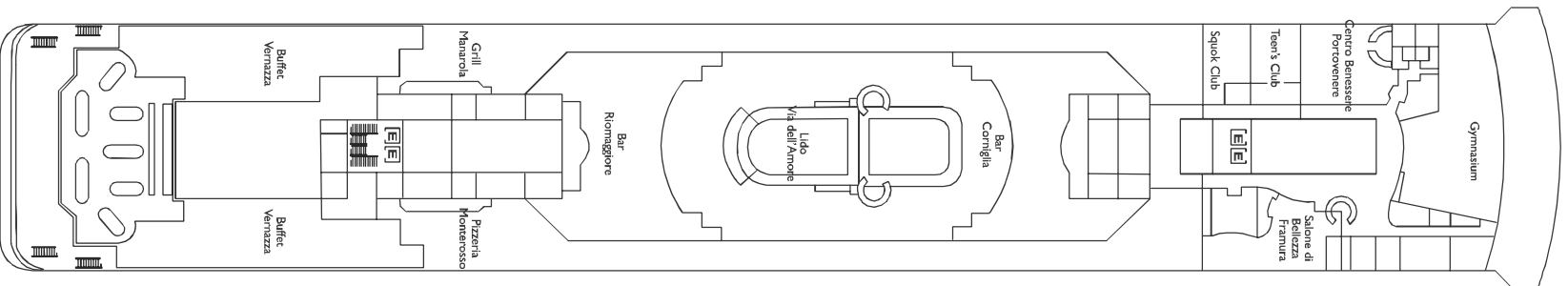

DECK 11 - CINQUE TERRE

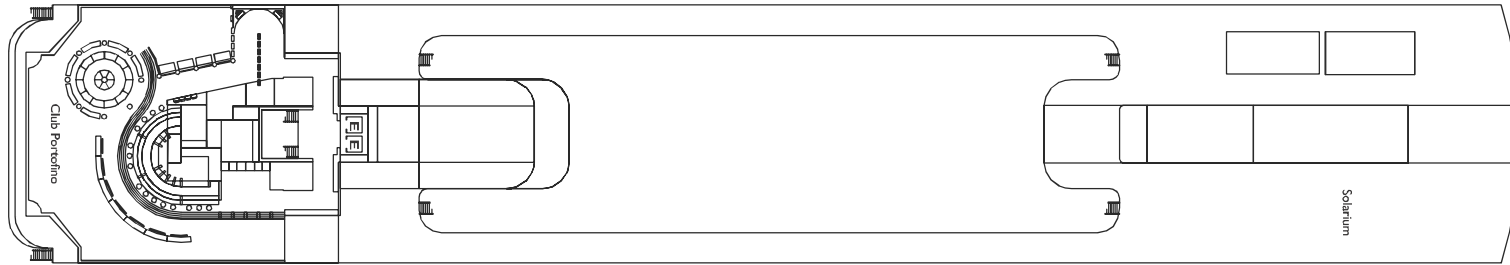

**DECK 12 - TIGULLIO**



**CLASSIC Cabins**  
Classic cabins are the **best value for money**. This is the **most economical choice** for each type of cabin (inside, outside & balcony) guaranteeing **full access to all services and facilities on board**. In addition, this category entitles you to accumulation of CostaClub (loyalty program) points and the **resulting benefits**.



**PREMIUM Cabins**  
Premium cabins include a series of added value services for Customers who like the pleasure of choosing. Premium cabins are located in the **best positions** on every deck of the ship and offer lots of extra services such as the **choice of 1<sup>st</sup> or 2<sup>nd</sup> sitting at the restaurant, breakfast in your cabin and room service 24/7** free of charge upon request. In addition, this category entitles you to accumulation of **twice the usual number of CostaClub points**. This category also entitles you to an **extra 10% discount** on a future cruise in a Premium cabin.



**SUITE Cabins**  
Suites and Grand Suites are synonymous with top-of-the-range services for high-end Customers. All the privileges reserved for Premium cabin Guests plus accommodation in a roomy, sophisticated Suite with exclusive amenities. You have **priority embarkation** and are welcomed by your own **Butler**, with a **bottle of spumante** and **delicacies** served directly in the Suite. You also have the privilege of **in-suite dining, a hot tub** and the choice of different types of pillow for customized comfort (**Pillow Menu**).

**Inside cabins**

- **Classic** Les Calanques, Provence
- **Premium** Les Calanques, Golfo Paradiso, Riviera dei Fiori

**Outside cabins with ocean view**

- **Classic** Les Calanques, Provence
- **Premium** Les Calanques, Golfo Paradiso, Riviera dei Fiori

**Cabins with ocean view balcony**

- **Classic** Golfo Paradiso, Riviera dei Fiori

**Luxury Suites**

- **Veranda Mini-Suites**  
Golfo Paradiso
- **Veranda Suites**  
Golfo Paradiso, Riviera dei Fiori
- **Veranda Panorama Suites**  
Provence, Les Calanques
- **Veranda Grand Suites**  
Provence, Les Calanques

**NB:** A double bed is available in cabins of all categories.  
A 3<sup>rd</sup> bed is available in cabins of all categories.  
A 4<sup>th</sup> bed is available in cabins of all categories except for Classic and Premium outside cabins.

- single cabins
- H cabins for disabled guests
- ζ connecting cabins
- E elevator
- \* sofa double bed
- 1 upper berth
- sofa single bed
- ▲▲ 2 lower berths that can't be converted into a double bed
- ▲ can't be converted into a double bed